

标准漏孔 Standard Leak



FFM-1000•2000 系列 Series

- 响应速度快，无需等待时间
- 受外界温度变化影响小
- 全金属结构，耐高压、耐冲击
- 可填充多种气体，应用范围广
- 调整压力可获得不同漏率





- Fast response without waiting time
- Small ambient temperature affect
- Metal structure with high pressure resistance and impact resistance
- Varied filling gas available with wide applied range
- Different leakage rates obtained through pressure adjustment



20MPa超高压, $10^{-4} \sim 10^{-9}$ Pa.m

Ultra-high pressure of 20MPa and leak rate of $10^{-4} \sim 10^{-9}$ Pa.m

无源漏孔 standard leak without air source	有源漏孔 standard leak with air source
FFM-1000系列 Series 	FFM-2000系列 Series 
一般使用压力-0.1~2.0MPa (G) Ordinary Working Pressure-0.1~2.0MPa (G)	灌装压力-0.1~1.0MPa (G) Filling Pressure -0.1~1.0MPa (G)
可直接嵌入被测物, 组成标准泄漏的基准物; 可直接安装在测试室上; 可接气源, 或者直接喷吹气体; Can be directly embedded in the measured work to be part of the master; Can be directly installed in the test cabinet; Can be connected to the air supply, or receive blowing gas	自带气源, 可填充各种气体; 填充气体压力可调; 通过调整压力, 可获得不同漏率; 可放入测试室中, 模拟被测物泄漏; Be equipped with air source with varied gas available; Filling gas pressure adjustable; Different leakage rates obtained through pressure adjustment Simulate the leakage of measured work when put in the test cabinet

压力—漏率曲线 Pressure-Leak Rate Curve

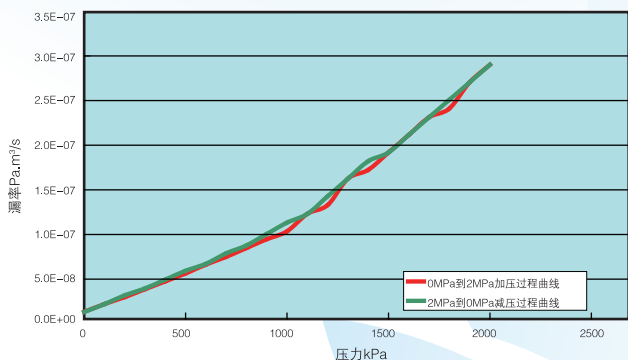

反复加压重复特性好。

温度曲线 Temperature Curve

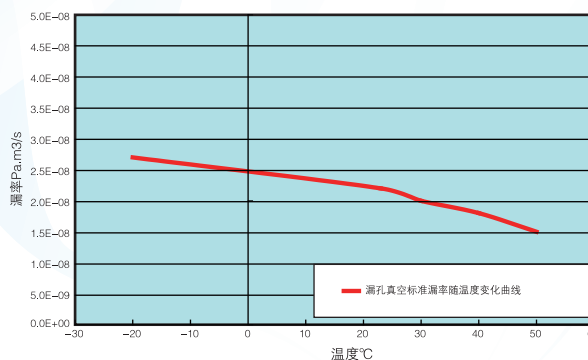

温度特性好, 温度变化对漏率影响小。

Excellent temperature characteristic ensures little effect on the leakage caused by temperature variation.

应用举例 Application examples

1. 标准漏孔可与检漏仪相连接, 用于校正检漏仪。还可用于检测检漏仪的最小可检漏率。

The standard leak can be connected to the air leak tester, in order to regulate the tester or confirm the minimum detectable leak rate.

2. 可将标准漏孔连接工件或同工件一起放入真空箱内, 用于制定良品/次品的泄漏标准, 以及日常维护检漏仪的使用。

The standard leak can be connected to the measured work, or put together with the measured work in the vacuum tank, in order to confirm the judgment standard of good product and defective product, or for the daily maintenance.

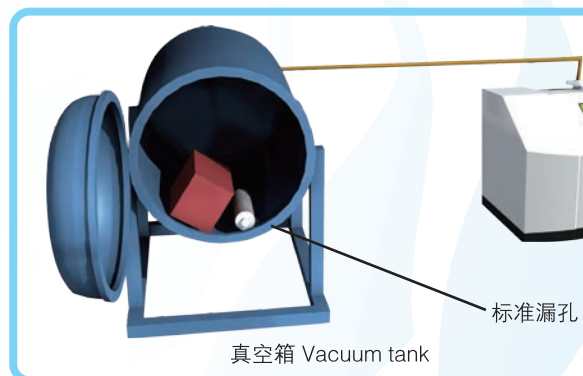

m³/s 漏率对应实际生产要求

Pa.m³/s meet the actual production requirements

产品选型 Model Selection

FFM		①	②	③	④	⑤	⑥	⑦	(规格: 压力) (Specification: Pressure)
型号 Model									
① 类型 Type	1	无源型 Without air source							
	2	有源型 With air source							
② 接口形式 Connection	1	法兰 KF16	Flange KF16						
	2	法兰 KF25	Flange KF25						
	3	M14 × 1.5 37° 球接锥面 37°	Pipe joints (QJ2889)						
	4	M14 × 1.5 60° 球接锥面 60°	Pipe joints (QJ2889)						
	5	R1/8							
	6	R1/4							
	7	Φ15.5直管	Φ15.5 Straight Pipe						
	8	吸枪专用锥口	Special counterbore for sniffer						
	X	其它	Other						
③ 压力类型 Pressure Type	V	真空标准漏孔 Vacuum pressure standard leak							
	P	正压标准漏孔 Positive pressure standard leak							
④ 气体种类 Gas Type	A	空气 Air							
	E	氦气 Helium							
	H	氢气(5%氢气+95%氮气) Hydrogen (5%H ₂ +95%N ₂)							
	N	氮气 Nitrogen							
⑤ 漏率等级 Pa.m ³ /s Leak Rate Level	A	1 × 10 ⁻⁹ ~ 5 × 10 ⁻⁹							
	B	6 × 10 ⁻⁹ ~ 9 × 10 ⁻⁹							
	C	1 × 10 ⁻⁸ ~ 5 × 10 ⁻⁸							
	D	6 × 10 ⁻⁸ ~ 9 × 10 ⁻⁸							
	E	1 × 10 ⁻⁷ ~ 5 × 10 ⁻⁷							
	F	6 × 10 ⁻⁷ ~ 9 × 10 ⁻⁷							
	G	1 × 10 ⁻⁶ ~ 5 × 10 ⁻⁶							
	H	6 × 10 ⁻⁶ ~ 9 × 10 ⁻⁶							
	I	1 × 10 ⁻⁵ ~ 5 × 10 ⁻⁵							
	J	6 × 10 ⁻⁵ ~ 9 × 10 ⁻⁵							
	K	1 × 10 ⁻⁴ ~ 5 × 10 ⁻⁴							
	L	6 × 10 ⁻⁴ ~ 9 × 10 ⁻⁴							
X	其它漏率, 标注规格 Other leak rate level. Please specify separately								
⑥ 随机资料 Delivery Attached Documentation	C	中文 Chinese							
	E	英文 English							
	J	日文 Japanese							
⑦ 证书 Certificate	N	标准随机资料 Standard							
	X	其他指定证书, 请单独标注 Required(Please specify the desired documents separately)							

- ※ 漏孔订货时需指定型号、压力。
随机资料包含: 合格证、说明书、检查成绩单。
-0.1~2.0 MPa 为标准品, 2.0MPa~20MPa需要订制。
- ※ Please specify the model and pressure range when ordering.
Delivery Attached Documentation includes certification, operation manual and test report.
Standard type: -0.1 ~ 2.0 MPa
Customized type: 2.0 MPa ~ 20 MPa

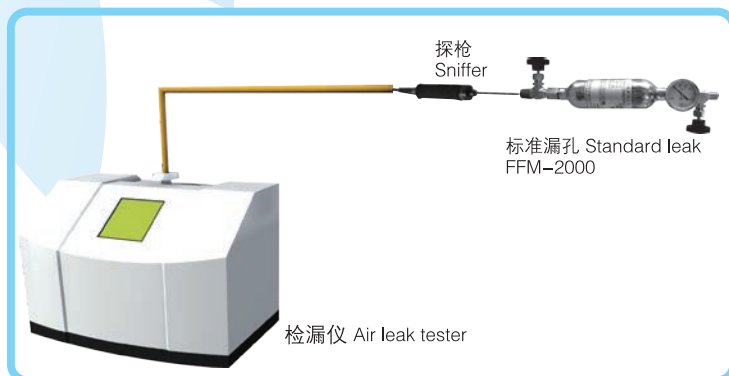

3.用于嗅探法
Sniffer Method

附表一 Schedule I

漏率 Leakrate Pa.m ³ /s							
一次侧压力kPa(G) Primary Side Pressure	二次侧压力kPa(G) Secondary Side Pressure	10 ⁻⁹ 量级 10 ⁻⁹ Magnitude	10 ⁻⁸ 量级 10 ⁻⁸ Magnitude	10 ⁻⁷ 量级 10 ⁻⁷ Magnitude	10 ⁻⁶ 量级 10 ⁻⁶ Magnitude	10 ⁻⁵ 量级 10 ⁻⁵ Magnitude	10 ⁻⁴ 量级 10 ⁻⁴ Magnitude
0	-100	√	√	√	√	√	√
100	0	×	√	√	√	√	√
200	0	×	√	√	√	√	√
300	0	×	×	√	√	√	√
400	0	×	×	√	√	√	√
500	0	×	×	√	√	√	√
600	0	×	×	√	√	√	√
700	0	×	×	√	√	√	√
800	0	×	×	√	√	√	√
900	0	×	×	√	√	√	√
1000	0	×	×	√	√	√	√
2000	0	×	×	×	√	√	√
适用气体 Applied Gas		仅氦气 Helium Only	全部 All	全部 All	全部 All	全部 All	全部 All

外形尺寸 Dimensions

单位 Unit: mm

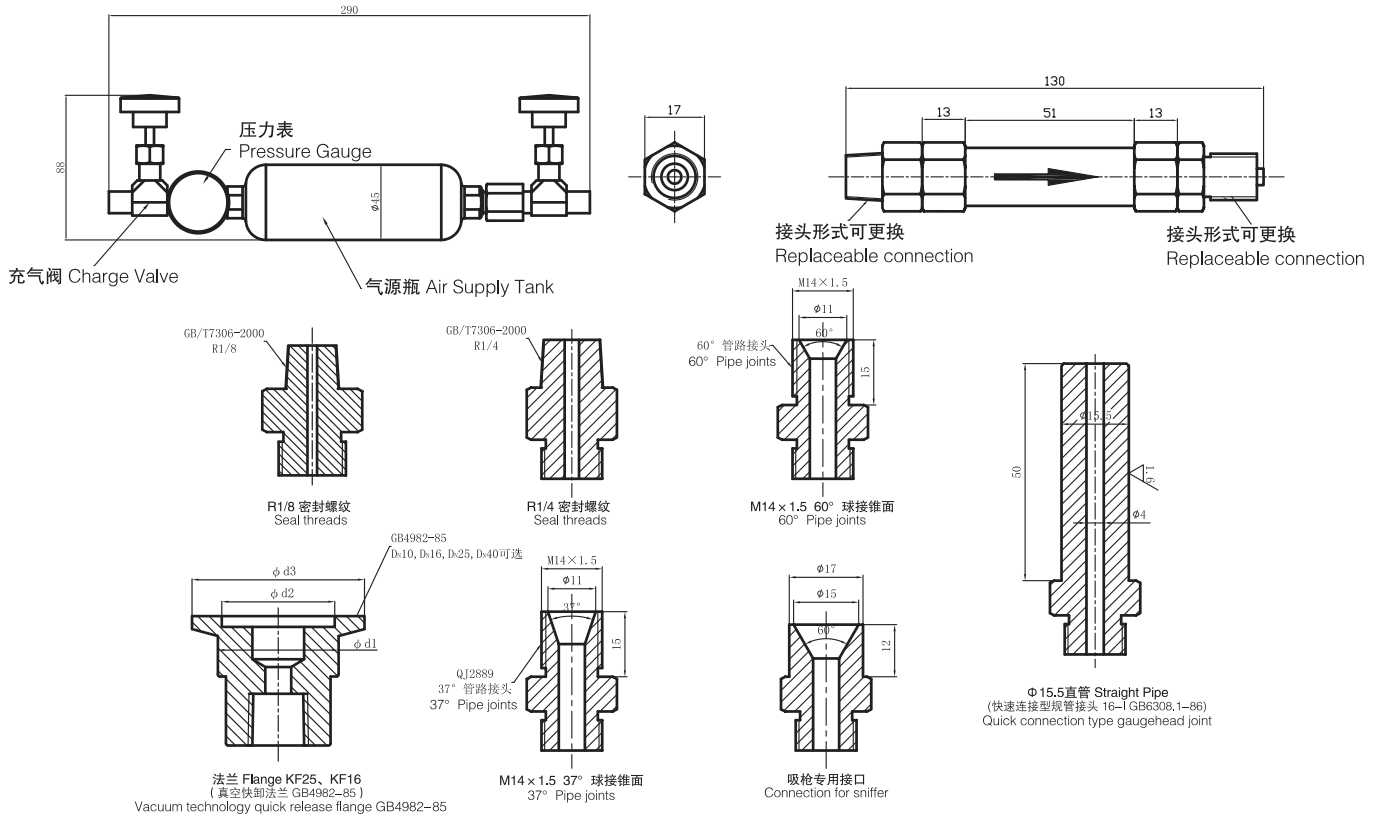

主要产品 ● 气密检测仪 ● 数字压力表 ● 流量计 ● 自动压力、流量控制器 ● 密封性能检测专用设备

BOYIE | 天津博益气动股份有限公司
TIANJIN BOYI PNEUMATICS CO., LTD.



代理经销商

公司·工厂: 天津开发区泰丰路80号 邮编: 300457

电话: (86)22-59810966 传真: (86)22-59810963

营销中心: 北京市丰台区角门18号名流未来大厦801-805室 邮编: 100068

电话: (86)10-87582461 传真: (86)10-87582462

网址: www.boyiqd.com 邮箱: sales@boyiqd.com



扫一扫, 查看
办事处地址

公司在深圳、顺德、杭州、上海、苏州、长沙、武汉、重庆、西安、青岛、沈阳设有分支机构。

C-BY-FFM1020-X-08

Printed in China